



A detailed photograph of an industrial lifting device, showing a central vertical shaft with a cylindrical component and a black corrugated hose connected to it. The device is mounted on a dark surface, and a pressure gauge is visible in the upper right corner of the image.

eT-Hover **Hebegeräte**
lifting devices



A grey line-art illustration of an industrial railing or safety fence, positioned at the bottom of the page.

02 Unser Unternehmen

our company

Wir setzen Ihre
Visionen
in die Tat um!



Seit vielen Jahren steht euroTECH für Kompetenz im Bereich Vakuum-Handling. Mit langjähriger Erfahrung und umfangreichen Know-How entwickeln wir innovative Lösungen für Industrie und Handwerk.

Am Anfang stand der Name euroTECH für Vakuumkomponenten und kleine Baugruppen. Mittlerweile bieten wir komplette Beschickungs-, Abstapel- und Kommissionieranlagen an.

Ein gut eingespieltes Team aus Konstrukteuren und Technikern erarbeitet in enger Zusammenarbeit mit dem Kunden Vorschläge und begleitet die Umsetzung von der ersten Auslegung bis zur finalen Übergabe beim Kunden.

For many years, euroTECH Vertriebs GmbH has stood for competence in the field of vacuum handling. Years of experience and know-how enables us find innovative solutions in mechanical engineering that ensures customer satisfaction.

Initially euroTECH was known for vacuum components and small assemblies. Today we provide complete loading-, stacking- and order picking systems.

A well-versed team of designers and technicians develop proposals in close cooperation with the customer, and accompanies the implementation from the first design to the final handover to the customer.

eT-Hover Hebezeuge lifting devices

Die Hebezeuge unserer Produktfamilie eT-Hover finden ein breites Anwendungsfeld in Produktionsstätten und auf Baustellen. Vom kompakten Seriengerät bis zum kundenorientierten Produkt findet sich eine große Bandbreite an Handlinglösungen.

Sie sind für das Handling von Lasten aus Holz, Glas, Blech/Metall, Kunststoff, Stein uvm. konzipiert.

Alle Vakuum-Hebezeuge entsprechen den Vorgaben der DIN EN 13155.

Moderne Handlinglösungen für den professionellen Einsatz

- » Alle Vakuum-Hebezeuge entsprechen den Vorgaben der aktuellen Sicherheitsstandards
- » Leichtes Verstellen der Quertraverse auf der Längstraverse
- » Ergonomisch gestaltete Bedieneinheit integriert sämtliche Funktionen in einem Gerät
- » Anzahl der Quertraverse und Saugplatten erweiterbar
- » Schnelles Lösen von Lasten durch Schnellbelüftungsfunktion
- » Zu allen Hebezeugen sind diverse Dichtungsgeometrien und -materialien lieferbar

Optional möglich:

- » Jede Saugplatte kann mit einem Kugelhahn abgesperrt werden
- » Längstraverse dient zusätzlich als Vakuumspeicher
- » Federnd aufgehängte, mit Kreuzklemmstücken aus Aluminium verstellbare Saugplatten

Lifting equipment from our eT-Hover product family has a wide range of applications in production facilities and on construction sites. A wide range of handling solutions can be found, from compact series equipment to customer-oriented handling solutions.

Our lifting devices are designed for the handling of different loads, made of wood, glass, sheet metal/metal, plastic and stone.

All vacuum lifting devices comply with the specifications of DIN EN 13155.

Modern handling solutions for professional use

- » All vacuum lifting devices comply with the requirements of current safety standards
- » Easy adjustment of the crossbars on the longitudinal traverse
- » Ergonomically designed operating unit integrates all functions in one device
- » Number of crossbars and suction plates can be expanded
- » Quick release of loads through quick ventilation function
- » Various seal geometries and sealing materials are available for all lifting devices

Optionally possible:

- » Each suction plate can be shut off with a ball valve
- » Spring-mounted suction plates, adjustable with aluminium cross clamps
- » Longitudinal crosshead additionally serves as vacuum reservoir

eT-Hover-panel



der Profi in Sachen horizontalem Plattenhandling

the expert for horizontal panel handling



Seite **06**
page

eT-Hover-grid

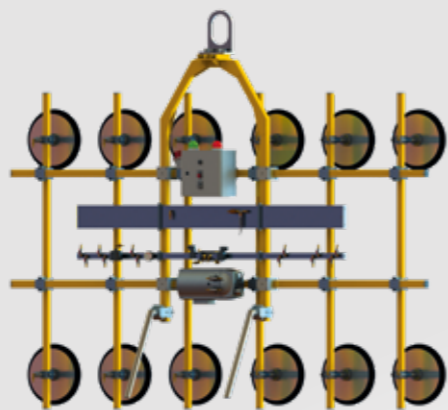

der Profi in Sachen vertikalem Plattenhandling

the expert for vertical panel handling



Seite **10**
page

eT-Hover-modesty



Schlicht und doch so vielfältig

so simple, yet so versatile

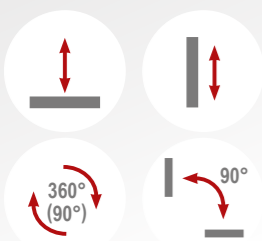

Seite **16**
page

eT-Hover-univac



modular erweiterbar durch Verlängerungsarme

modular expansion with extension arms

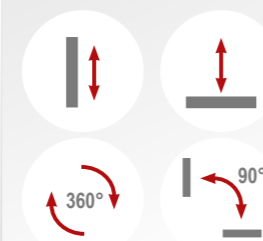

Seite **18**
page



EUROTECH
eT-Hover

eT-Hover-element



Schwenken mit Hilfe der Schwerkraft

gravity-assisted pivoting

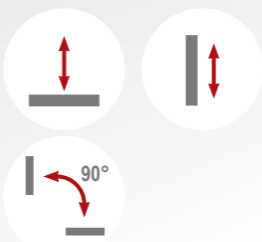

Seite **12**
page

eT-Hover-loop



die einfache Art, Lasten um 180° zu wenden

the easy way of turning loads by 180°

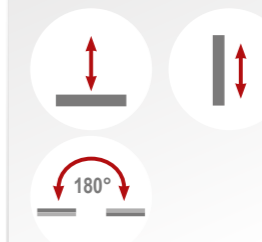

Seite **14**
page

eT-Hover-univac line



kompakt und leicht

compact and lightweight

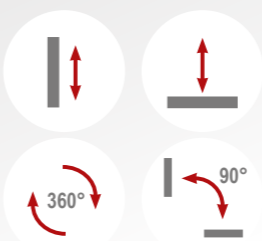

Seite **22**
page

eT-Hover-allround



das Multitalent unter den Hebegeäten

the all-round lifting device

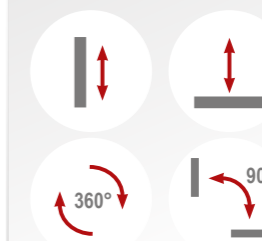

Seite **23**
page

06 eT-Hover-panel

eT-Hover-panel

the expert for horizontal panel handling

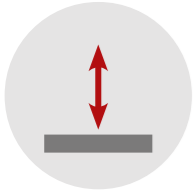

- » Horizontales Heben vakuumdichter Lasten wie Glasscheiben, Kunststoffplatten, dichte Holzplatten, uvm.
- » Tragfähigkeit je nach Ausführung: bis 4.000 kg
- » Auch in flacher Ausführung verfügbar (Seite 9)

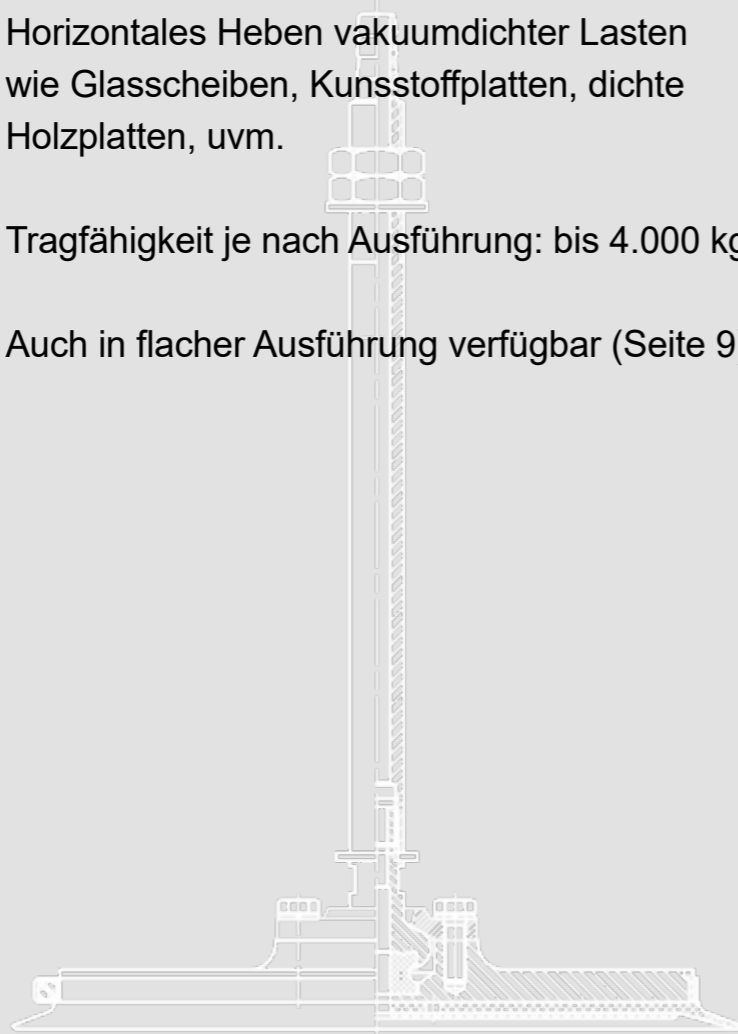

- » horizontal lifting of vacuum-tight loads like glass panes, plastic sheets, dense wooden boards, etc.
- » load capacity depending on version: 4.000 kg
- » also available in flat design (page 9)

der Profi in Sachen horizontalem Plattenhandling



Beispielgeräte | Sample devices

Typ Type eT-Hover-panel	Tragfähigkeit (kg) carrying capacity (kg)	Maße Last bis (mm) load dimensions up to (mm)	Vakuumerzeugung vacuum generation	Maße LxBxH (mm) Dimensions LxWxH (mm)	Eigengewicht (kg) self-weight (kg)	Art.-#
HG HF 270 06 SKA	270	6300 x 6000	BSKV-SV 400/1	2000 x 1000 x 1027	180	B013972
HG HF 500 04 290 RL	500	3000 x 1500	VT 4.8, 8 m ³ trockenlaufend/ dry-running	1800 x 1090 x 880	100	B013182
HG HF 1200 08 290 RL	1200	4000 x 2000	VT 4.8, 8 m ³ trockenlaufend/ dry-running	3000 x 1410 x 1086	202	B012703
HG HF 1500 08 320 RL	1500	6000 x 2000	VT 4.8, 8 m ³ trockenlaufend/ dry-running	4500 x 1200 x 1073	260	B012955
HF 2000 04 290 RL	2000	4000 x 2000	U4.20, 18 m ³	2800 x 1200 x 1193	312	B012636
HG HF 4000 04 OVA	4000	4000 x 1500	VT 4.20, 20 m ³ trockenlaufend/ dry-running	3690 x 805 x 1092	325	F001959

Flache Ausführung

flat version

08 eT-Hover-panel

eT-Hover-panel

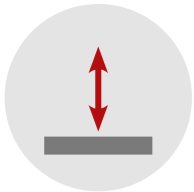

- » Horizontales Heben vakuumdichter Lasten wie Blech, Kunststoffplatten, dichte Holzplatten, uvm.
- » Tragfähigkeit bis 500 kg
- » Flache Ausführung, nur ca. 40 cm hoch

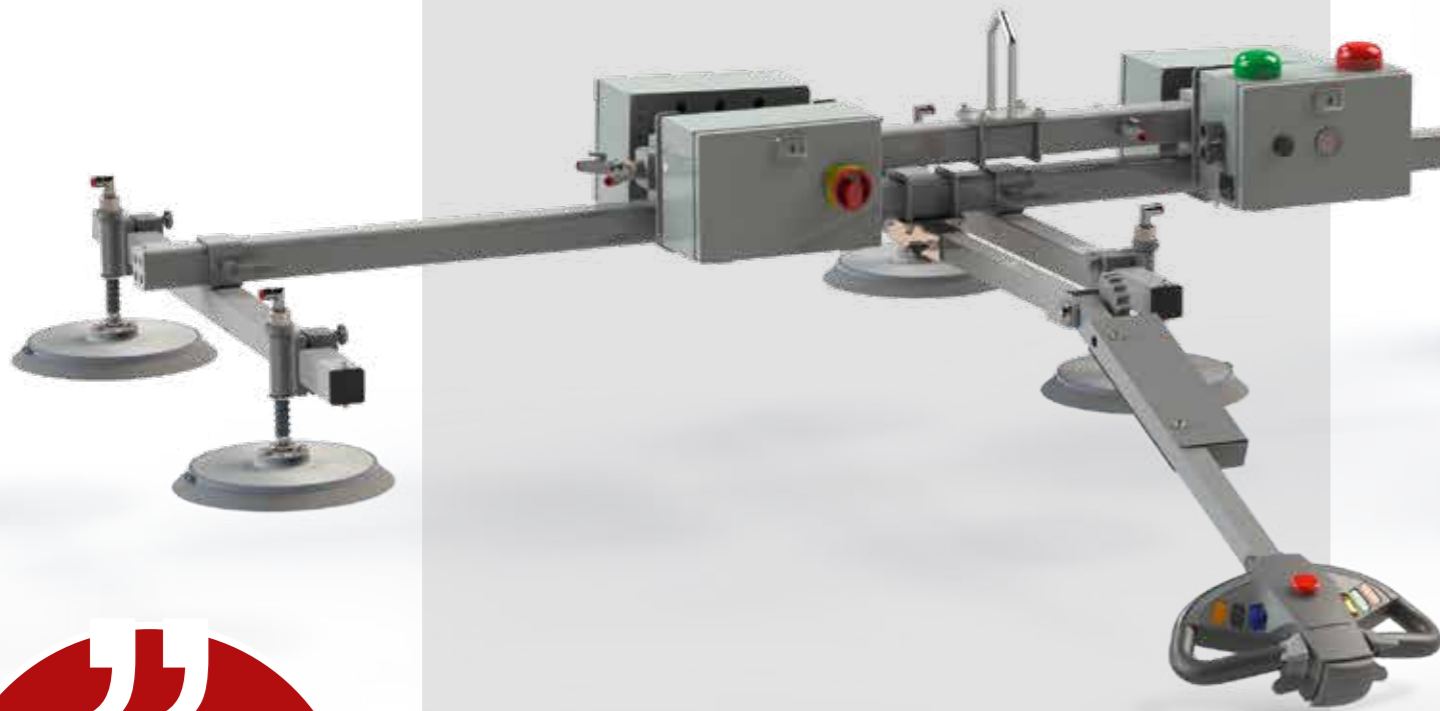

“
the expert for
horizontal panel
handling

- » horizontal lifting of vacuum-tight loads like metal sheets, plastic sheets, dense wooden boards, etc.
- » load capacity up to 500 kg
- » flat design, only approx. 40 cm high

Beispielgeräte | Sample devices

Typ Type eT-Hover-panel	Tragfähigkeit (kg) carrying capacity (kg)	Maße Last bis (mm) load dimensions up to (mm)	Vakuumerzeugung vacuum generation	Maße LxBxH (mm) Dimensions LxWxH (mm)	Eigengewicht (kg) self-weight (kg)	Art.-#
HG HF 500 06 230 RL	500	x	VT 4.8, 8 m ³ trockenlaufend/ dry-running	3000 x 1200 x 1086	80	B015135
HG HF 750 06 320 RL	750	x	VT 4.8, 8 m ³ trockenlaufend/ dry-running	3000 x 1200 x 1086	127	B015037

10 eT-Hover-grid

eT-Hover-grid

the expert for vertical panel handling

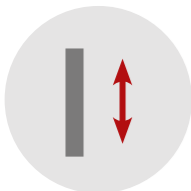

- » Vertikales Heben vakuumdichter Lasten wie Glasscheiben, Kunststoffplatten, dichte Holzplatten, uvm.
- » Tragfähigkeit je nach Ausführung bis 1500 kg

der Profi in Sachen vertikalem Plattenhandling



MTC Saugplattenüberzüge
MTC suction plate covers

Kennen Sie schon unsere Saugplattenüberzüge?
Diese verhindern Saugerabdrücke und Reibeschäden auf empfindlichen Oberflächen. Wir beraten Sie gerne bezüglich der Haltekraft beim Einsatz der Saugplattenüberzüge, welche in verschiedenen Größen, auch für ovale Sauger, verfügbar sind.

Do you already know our suction plate covers?
These prevent suction plate impressions and friction damage on sensitive surfaces. We would be pleased to advise you on the holding force when using the suction plate covers, which are available in different sizes, also for oval suction cups.

- » vertical lifting of vacuum-tight loads like glass panes, plastic sheets, dense wooden boards, etc.
- » load capacity depending on the model up to 1500 kg

Beispielgeräte Sample devices						
Typ Type eT-Hover-grid	Tragfähigkeit (kg) carrying capacity (kg)	Maße Last bis (mm) load dimensions up to (mm)	Vakuumzeugung vacuum generation	Maße LxBxH (mm) Dimensions LxWxH (mm)	Eigengewicht (kg) self-weight (kg)	Art.-#
HG VF 1000 8 400 RL	1000	2800 x 2800	VT 4.8, 8 m ³ trockenlaufend/ dry-running	1800 x 1300 x 2003	205	B014706
HG VF 1500 12 400 RL	1500	3300 x 3000	VT 4.8, 8 m ³ trockenlaufend/ dry-running	3000 x 1200 x 1086	210	F001958
HG VF 1500 12 400 RL	1500	3300 x 3000	VT 4.8, 8 m ³ trockenlaufend/ dry-running	3000 x 1200 x 1086	225	B010270

12 eT-Hover-element

eT-Hover-element

gravity-assisted pivoting

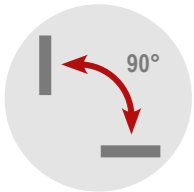
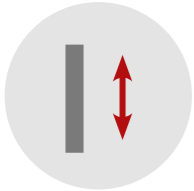
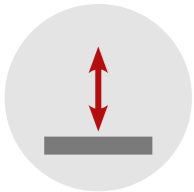

» horizontales und/oder vertikales Handling, manuelles Schwenken

» Tragfähigkeit je nach Ausführung von 500 bis 1000 kg

Schon gewusst?

Wir bieten die UVV Abnahme für Hebegeräte und Anlagen aller Hersteller. Die Unfallverhütungsvorschriften (UVV) stellen für jedes Unternehmen und jeden Versicherten der gesetzlichen Unfallversicherung verbindliche Pflichten bezüglich Arbeitssicherheit und Gesundheitsschutz am Arbeitsplatz dar. Eine dieser Pflichten ist die jährliche UVV Prüfung von Hebegeräten und Lastaufnahmemitteln.

Already know?

We offer the UVV acceptance for all devices and plants of all manufacturers. The Accident Prevention Regulations (UVV) are binding obligations for every company and every person insured under the statutory accident insurance scheme with regard to occupational safety and health protection at the workplace. One of these obligations is the annual UVV inspection of lifting devices and load handling equipment.



» horizontal and/or vertical handling, manual pivotin

» load capacity depending on the model from 500 up to 1000 kg



Schwenken mit Hilfe der Schwerkraft

Ihre Vorteile als Kunde von euroTECH:

- » Langjährige Erfahrung in den Bereichen: Vakuumhebertechnik, -komponenten, Maschinenbau
- » Alle UVV-Abnahmen mit Prüfprotokoll und Freigabe für 1 Jahr durch Sicherheitsplakette
- » Abnahme direkt vor Ort, uvm.

Your advantages as a customer of euroTECH:

- » Many years of experience in the fields: vacuum lifting technology, components, mechanical engineering
- » All UVV acceptances with test protocol and release for 1 year by safety badge
- » Acceptance directly on site and much more.

Beispielgeräte | Sample devices

Typ Type eT-Hover-element	Tragfähigkeit (kg) carrying capacity (kg)	Maße Last bis (mm) load dimensions up to (mm)	Vakuumerzeugung vacuum generation	Maße LxBxH (mm) Dimensions LxWxH (mm)	Eigengewicht (kg) self-weight (kg)	Art.-#
HG SF 700 8 320 RL	700	6000 x 3200	VT 4.8, 8 m ³ trockenlaufend/ dry-running	4000 x 1100 x 300	135	F001954
HG SF 1000 10 320 RL	1000	6000 x 3200	VT 4.8, 8 m ³ trockenlaufend/ dry-running	4000 x 1100 x 300	135	B008796

14 eT-Hover-loop

eT-Hover-loop

the easy way of turning loads by 180°

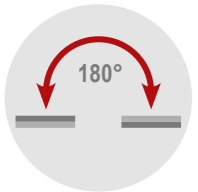
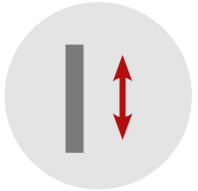
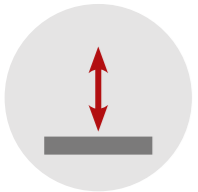

- » horizontales und/oder vertikales Handling, sowie zum Wenden von Lasten um 180° mittels Linearantrieb
- » Je nach Ausführung für flächige Lasten oder Trapezprofile
- » Tragfähigkeit je nach Ausführung 500 kg

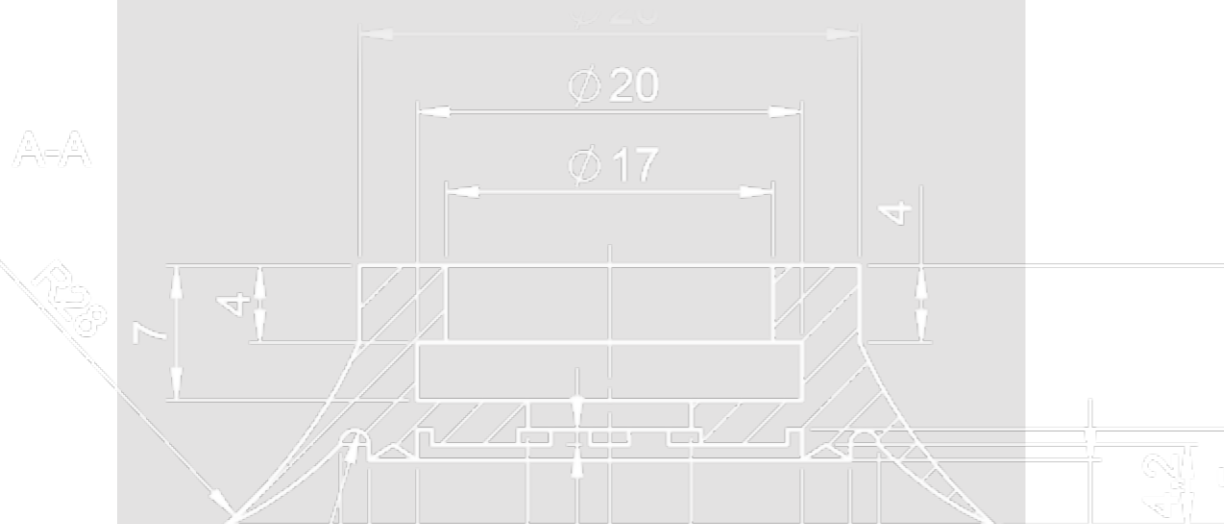

- » horizontal and/or vertical handling, as well as for turning loads by 180° by means of linear drive
- » Depending on design for flat loads or trapezoidal profiles
- » load capacity depending on design 500 kg



Beispielgeräte | Sample devices

Typ Type eT-Hover-loop	Tragfähigkeit (kg) carrying capacity (kg)	Maße Last bis (mm) load dimensions up to (mm)	Vakuumerzeugung vacuum generation	Maße LxBxH (mm) Dimensions LxWxH (mm)	Eigengewicht (kg) self-weight (kg)	Art.-#
HG SF 250 04 290 RL	250	3500 x 2000	Membranpumpe/ Diaphragm pump 3,6 m³ 24 V DC	2000 x 800 x 1500	110	B010636
HG SF 250 08 180 TL	250	3500 x 2000	VT 4.8, 8 m³ trockenlaufend/ dry-running	2000 x 800 x 1500	110	B013165
HG SF 250 08 232 SCP	250	3500 x 2000	Membranpumpe/ Diaphragm pump 3,6 m³ 24 V DC	2800 x 1500 x 880	170	B014848
HG SF 250 08 290 RL	250	6000 x 1200	Membranpumpe/ Diaphragm pump 3,6 m³ 24 V DC	4000 x 880 x 1500	170	B013150
HG SF 500 08 320 RL	500	5500 x 2000	VT 4.8, 8 m³ trockenlaufend/ dry-running	4200 x 1200 x 1600	300	F002308

16 eT-Hover-modesty

eT-Hover-modesty

so simple, yet so versatile

- » horizontales und/oder vertikales Handling sowie manuelles oder pneumatisches Drehen
- » Betrieb komplett mit Druckluft
- » Tragfähigkeit je nach Ausführung 250 kg

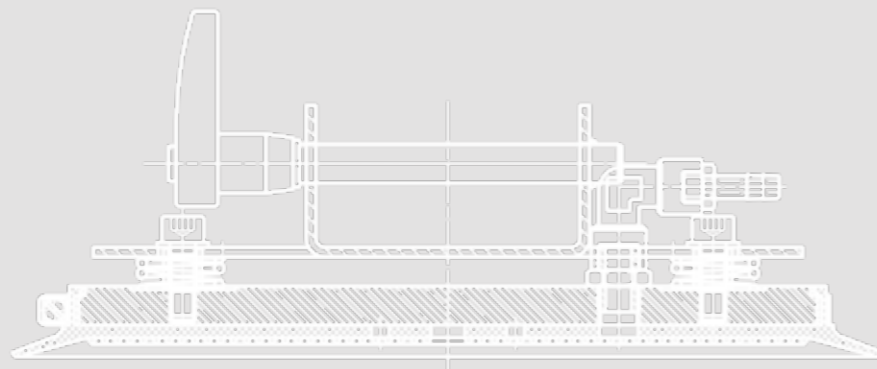

- » horizontal and/or vertical handling as well as manual or pneumatic turning
- » completely operated with compressed air
- » load capacity depending on design 250 kg

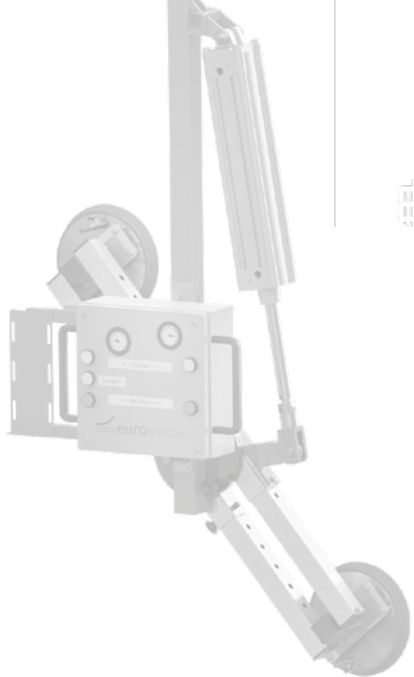
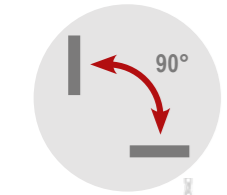
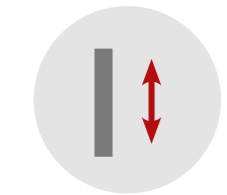
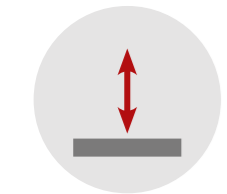

schlicht und doch so vielfältig

Beispielgeräte | Sample devices

Typ Type eT-Hover-modesty	Tragfähigkeit (kg) carrying capacity (kg)	Maße Last bis (mm) load dimensions up to (mm)	Vakuumerzeugung vacuum generation	Maße LxBxH (mm) Dimensions LxWxH (mm)	Eigengewicht (kg) self-weight (kg)	Art.-#
HG SF 250 04 290 RL	230	1500 x 1500	Ejektor ejector	470 x 315 x 558	7	B013271
HG VD 150 02 240 L	150	2000 x 1500	Ejektor ejector	1500 x 400 x 488	27	B010736
HG VD 150 02 240 L	150	2000 x 1500	Ejektor ejector	1500 x 400 x 1230	35	B010776
HG VD 250 02 350 RL	250	2000 x 1500	Ejektor ejector	1500 x 400 x 1230	35	B010331
HG SD 600 04 400 RL	250	2000 x 1500	Ejektor ejector	1500 x 1500 x 993	48	B014180
HG SD 250 02 350 RL	250	2000 x 1500	Ejektor ejector	1025 x 488 x 1088	40	B013553

Baustellengeeignet durch Zweikreisystem

Suitable for construction sites due to dual-circuit system

18 eT-Hover-univac

eT-Hover-univac

modular expansion with extension arms

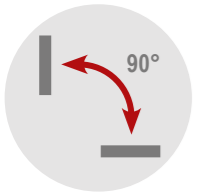
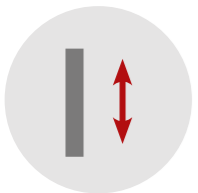
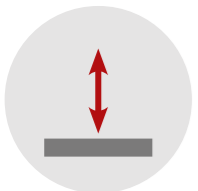

- » horizontales und/oder vertikales Handling sowie manuelles Drehen & manuelles oder elektrisches Schwenken
- » für Indoor und Outdoor lieferbar
- » modular erweiterbar
→ verschiedene Formate der Lasten möglich
- » Tragfähigkeit 500 kg, bei Erweiterung 700 kg

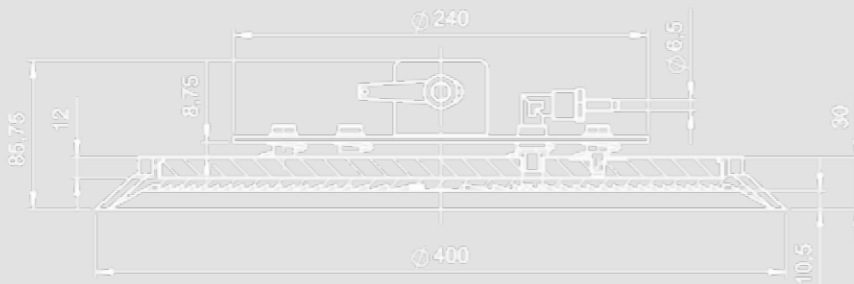

- » horizontal and/or vertical handling and manual turning & manual or electrical pivoting
- » available for indoor and outdoor
- » modular expandable
→ different formats of loads possible
- » Load capacity 500 kg, with extension 700 kg

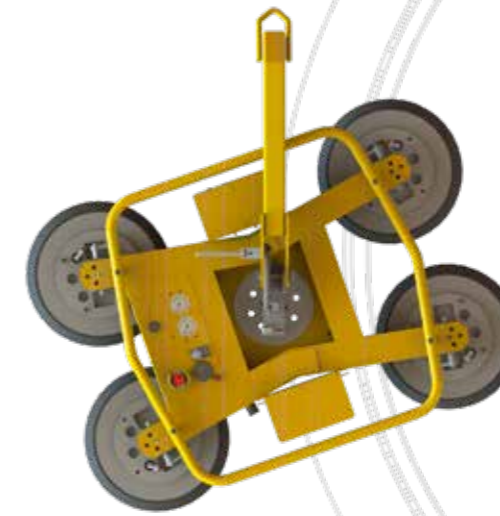

modular erweiterbar durch Verlängerungsarme



Beispielgeräte | Sample devices

Typ Type eT-Hover-univac	Tragfähigkeit (kg) carrying capacity (kg)	Maße Last bis (mm) load dimensions up to (mm)	Vakuumerzeugung vacuum generation	Maße LxBxH (mm) Dimensions LxWxH (mm)	Eigengewicht (kg) self-weight (kg)	Art.-#
HG SD 360 04 400 RL	500 h 360 v	3800 x 1500	Membranpumpe/ Diaphragm pump 2,1 m³/h, 12 V DC	1000 x 340 x 10,5	60	F001947

h = horizontal / horizontally | v = vertikal / vertical

Baustellengeeignet durch Zweikreissystem
Suitable for construction sites due to dual-circuit system

20 eT-Hover-univac

eT-Hover-univac

eT-Hover-univac-line

eT-Hover-univac-line

Zubehör
accessories

Bezeichnung	Artikelnummer
Kabelfernbedienung für Hebegeräte	B006805
Funkfernbedienung für Hebegeräte	B006035
Verlängerungsarm für eT-Hover-univac	B008894
Zusatzsaugplatten mit Halterung rechts	B008863
Zusatzsaugplatten mit Halterung links	B008864
Verlängerung (für Hebe-/Schiebe-Elemente)	B008852
Schutzüberzüge (in Kunstleder, nur für Transport)	M010402
Transportkiste für Hebegerät	B000004
Transportkiste für 4 Zusatzsaugplatten	B000005
Tragarm mit elektrischem Hubzylinder für eT-Hover-univac	B007128
Transportgestell für Hebegerät eT-Hover-univac	B010081

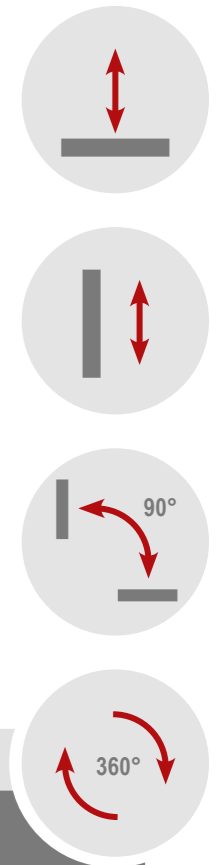

Discription	Article number
Cable remote control for lifting devices	B006805
Wireless remote control for lifting devices	B006035
Extension arm for eT-Hover-univac	B008894
Additional suction plates with mounting bracket on the right	B008863
Additional suction plates with mounting bracket on the left	B008864
Extension (for lifting/sliding elements)	B008852
Protective covers (in synthetic leather, only for transport)	M010402
Transport box for lifting device	B000004
Transport box for 4 additional suction plates	B000005
Carrier arm with an electric lifting cylinder for eT-Hover-univac	B007128
Transport rack for eT-Hover-univac lifting device	B010081

Beispielgeräte Sample devices						
Typ Type eT-Hover-univac-line	Tragfähigkeit (kg) carrying capacity (kg)	Maße Last bis (mm) load dimensions up to (mm)	Vakuumerzeugung vacuum generation	Maße LxBxH (mm) Dimensions LxWxH (mm)	Eigengewicht (kg) self-weight (kg)	Art.-#
HG SD 80 02 290 RL	80	2500 x 1500	Membranpumpe/ Diaphragm pump 2,1 m³/h, 12 V DC	1500 x 320 x 349	45	B014563
HG SD 110 02 320 RL	110	2500 x 1500		1500 x 320 x 349	50	B013695
HG SD 220 04 320 RL	220	2500 x 1500		1500 x 320 x 349	65	B013296
HG SD 360 04 400 RL	360	3500 x 3000		1500 x 320 x 349	69	B012727

Drehbereich / rotation range: 360° manuel endlos / manually endlessly (rastend alle / locking every 90°)
 Schwenkbereich / Pivoting range: manuel / manually 90°

22 eT-Hover-allround

eT-Hover-allround

the all-round lifting device

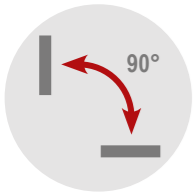
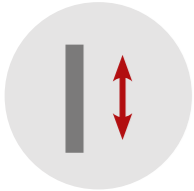
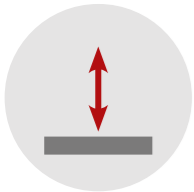

» horizontales und/oder vertikales Handling sowie Drehen und/oder Schwenken

» Tragfähigkeit 250/500 kg



» horizontal and/or vertical handling and manual turning & manual or electrical pivoting

» Load capacity 250/500 kg

das
Multitalent
unter den
Hebegegeräten

Beispielgeräte | Sample devices

Typ Type eT-Hover-allround-SF	Tragfähigkeit (kg) carrying capacity (kg)	Maße Last bis (mm) load dimensions up to (mm)	Vakuumerzeugung vacuum generation	Maße LxBxH (mm) Dimensions LxWxH (mm)	Eigengewicht (kg) self-weight (kg)	Art.-#
HG SF 100 08 120 RL	100	3800 x 1500		3000 x 1200 x 1400	112	B012646
HG SF 200 04 BBSC 250 R	200	1500 x 600	Membranpumpe/ Diaphragm pump 3,6 m³ 24 V DC	1300 x 880 x 1271	85	B014509
HG SF 250 04 290 RL	250	2500 x 1500		1500 x 800 x 1271	85	B010884
HG SF 250 04 400 RL	250	2500 x 1500	Seitenkanal- verdichter	1800 x 880 x 1490	150	B014330
HG SF 250 06 230 RL	250	4000 x 1500		2800 x 1200 x 1265	88	B011207
HG SF 250 06 232 SCP	250	4000 x 1500	Membranpumpe/ Diaphragm pump 3,6 m³ 24 V DC	2800 x 1200 x 1265	88	B014461
HG SF 250 06 290 RL	250	4000 x 1500		2800 x 1200 x 1265	110	B009978
HG SF 500 04 400 RL	500	2500 x 1500		1800 x 1000 x 1271	85	B013380
eT-Hover-allround-VD						
HG VD 150 02 290 RL	150	2500 x 1500		1080 x 1100 x 1315	86	F001941
HG VD 250 04 290 RL	250	2500 x 1500		1500 x 880 x 1490	110	B011465
HG VD 250 08 200 RL	250	2500 x 1500	Membranpumpe/ Diaphragm pump 3,6 m³ 24 V DC	1625 x 718 x 1437	102	B010537
HG VD 400 06 290 RL	400	3500 x 3000		2150 x 1172 x 1825	130	B011916
HG VD 500 04 400 RL	500	3500 x 3000		2150 x 1172 x 1825	130	B010032
eT-Hover-allround-SD						
HG SD 250 04 290 RL	250	2500 x 1500	Membranpumpe/ Diaphragm pump 3,6 m³ 24 V DC	1500 x 880 x 1490	110	B009912
HG SD 500 04 400 RL	500	2500 x 1500		2500 x 1835 x 1400	130	B012642
eT-Hover-allround-SD Drehbereich / rotation range: 90° Schwenkbereich / Pivoting range: pneumatisch / pneumatically 90°						
HG SD 500 04 400 RL	500	2500 x 1500	Ejektor	2150 x 1172 x 1825	130	B011038

24 Legende explanation of symbols

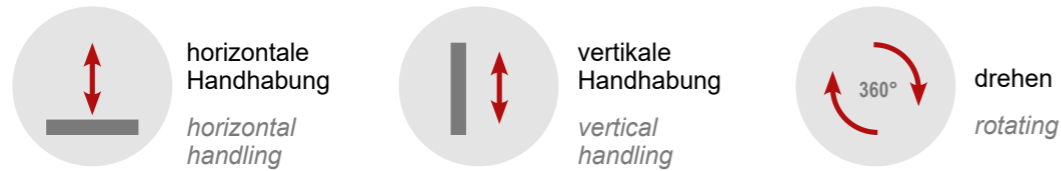

HD = horizontal drehbar
horizontal rotate
 VD = vertikal drehbar
vertical rotate
 SD = schwenkbar + drehbar
pivot + rotate
 HF = horizontal fest
fixed horizontal
 VF = vertikal fest
fixed vertical
 SF = schwenkbar fest
fixed pivoting

Der ergonomische Bediengriff für komfortables Plattenhandling ohne Kraftaufwand

Durch die ergonomisch gestaltete Bedieneinheit ist eine einfache Bedienung der damit ausgestatteten eT-Hover Hebegeräte garantiert. Der Bediengriff integriert sämtliche Funktionen wie Saugen, Belüften, Drehen, Schwenken und Kran auf/ab in einem Gerät. Viele Geräte sind mit einer Abblasfunktion ausgestattet, um ein sicheres Absetzen der Werkstücke zu gewährleisten.

The ergonomic operating handle for comfortable board handling without effort

Due to the ergonomically designed control unit, easy operation of the eT-Hover lifting devices is guaranteed. The operating handle integrates all Functions such as suction, ventilation, turning, slewing and crane up/down in one device. Many devices are equipped with a blow-off function to ensure safe depositing of the workpieces.

ergonomischer Bediengriff operating handle

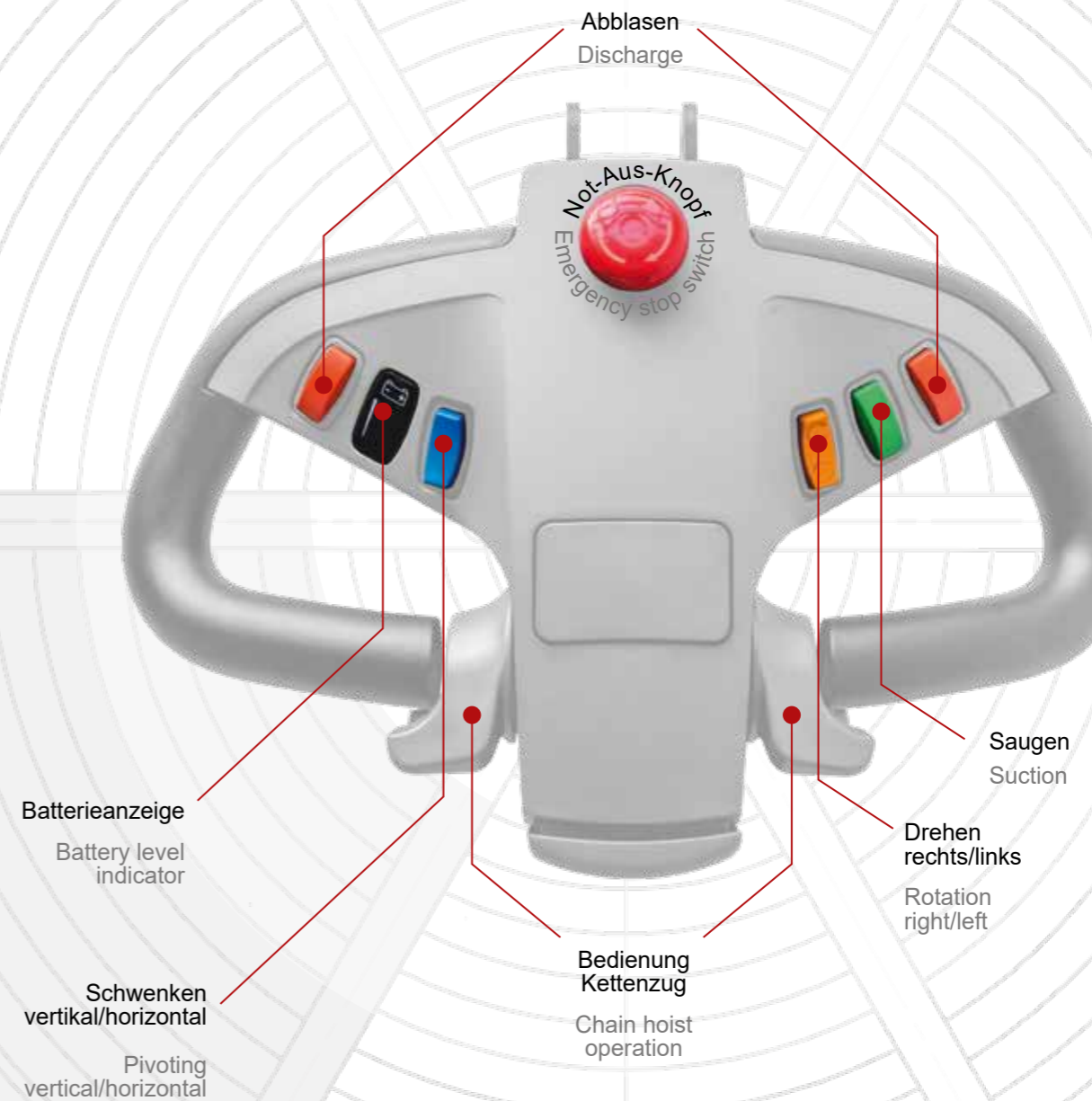

26 Beispiele für kundensorientierte Lösungen

examples of customer-oriented solutions

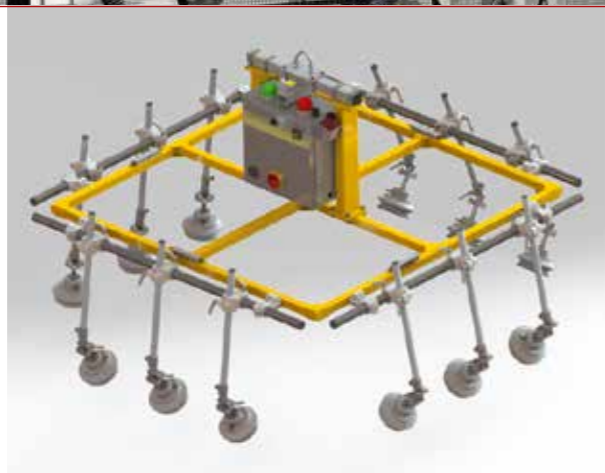
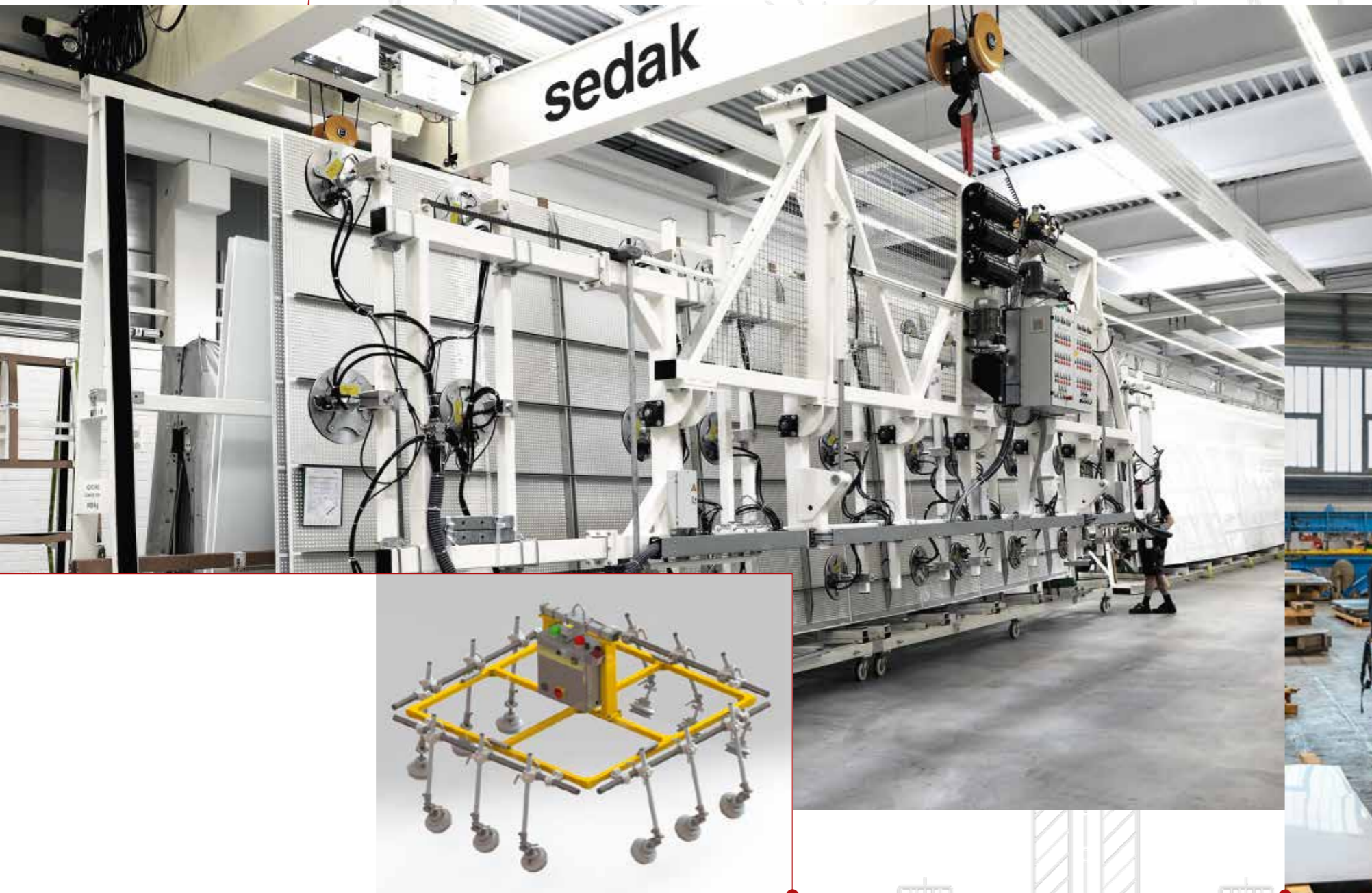



euROTECH Vertriebs GmbH

Maybachstr. 7
72348 Rosenfeld
Germany

Telefon: +49 7428 93912-0
Fax: +49 7428 93912-13
E-Mail: info@etvac.de Internet:
www.etvac.de